

MASTER VIEW PRO

2 Console / 8 Computer KVM Switch



USER MANUAL

CS-228

2001-02-01

2001-02-01

PACKING LIST

The complete Master View CS-228 package consists of:

- ◆ 1 CS-228 KVM Switch
- ◆ 1 Power Adapter
- ◆ 2 Rack Mounting Brackets (Screws Included)
- ◆ 1 User Manual

Check to make sure that the unit was not damaged in shipping. If you encounter a problem, contact your dealer.

Please read this manual thoroughly and follow the installation and operation procedures carefully to prevent any damage to the unit, and/or any of the devices connected to it.

Version 1.0
©Copyright 2000 ATEN™ International Co., Ltd.
Manual Part No. PAPE-0180-100
Printed in Taiwan 02/2001

All brand names and trademarks are the registered property of their respective owners.

CONTENTS

Overview	1
Features	2
Hardware Requirements	3
Consoles	3
Computers	3
Cables	3
Introduction	4
Front View	4
Rear View	5
Installation and Startup	6
Before you Begin	6
Single Station Installation	6
Two Stage Installation	7
Operation	9
Hot Plugging	9
Powering Off and Restarting	9
Port Selection	9
OSD Operation	10
OSD Overview	10
Port Numbering	11
OSD Navigation	11
OSD Main Menu Headings	12
OSD Functions	12
Factory Default Settings	18
Appendix	19
Master View - Computer Connection Tables	19
Troubleshooting	19
Specifications	20
Stacking and Mounting	21
Radio & TV Interference Statement	22
Limited Warranty	22

OVERVIEW

The CS-228 KVM Switch is a control unit that allows two independent keyboard, mouse, and monitor Consoles to access eight computers, either independently or on a multiuser shared basis, in a convenient, cost effective manner. A Master View CS-228 unit can control up to 8 PCs. Since it can be cascaded one level down to a CS-138A, CS-9138, CS-128A, or CS-124A, up to 9 Master View units (the CS-228 plus eight cascaded ones), can control up to 64 computers from either of the two Consoles.

Setup is fast and easy; plugging cables into their appropriate ports is all that is entailed. There is no software to configure, so there is no need to get involved in complex software installation routines or be concerned with incompatibility problems. Because the CS-228 intercepts keyboard input directly, it works on any hardware platform and with all operating systems.

The CS-228 provides a convenient OSD (On Screen Display), function that allows either of the two Consoles to access any computer connected to the system by means of an on screen, menu driven interface. A powerful *Quick View Scan* feature allows auto scanning and monitoring the activities of all operating computers on the installation one by one.

For security, two level password protection (administrator and user), is provided in order to prevent unauthorized access to the computers. Responding to the growing use of audio input/output in the workstation space, the CS-228 has been designed with built in microphone and speaker support, as well.

There is no better way to save time and money than with a Master View CS-228 installation. By allowing all the attached computers to be managed from two separate Consoles, a Master View CS-228 installation: (1) eliminates the expense of having to purchase a separate keyboard, monitor, and mouse for each computer; (2) saves all the space those extra components would take up; (3) saves on energy costs; and (4) eliminates the inconvenience and wasted effort involved in constantly moving around from one computer to another, while allowing a single user to access the computers from several different convenient locations, or for two users to share them.

FEATURES

- ◆ 2 Consoles Control 8 Computers
- ◆ One or Two Users Can Operate Up To 64 Computers (via Daisy Chain to CS-138A, CS-9138, CS-128A, or CS-124A) At The Same Time
- ◆ Each Console Has Its Own Access Control
- ◆ Two Level Password Security (One Administrator; Four User Passwords)
- ◆ Administrator Can Access Any Computer Completely Independently of The Other Users
- ◆ Each User Has His Own Access Control List
- ◆ Port Selection via OSD (On Screen Display)
- ◆ Auto Expansion of The OSD Port List For Cascaded Installations
- ◆ OSD Automatically Adjusts to Resolution Changes
- ◆ Hot Pluggable - Add or Remove any Computer without Powering Off the Switch
- ◆ Auto Scan Function Provides Easy Monitoring of All Computers
- ◆ Supports 1920 x 1440 Resolution; DDC2 (Display Data Channel 2)
- ◆ PS/2 Compatible Mouse Support: Microsoft Intellimouse Pro, Logitech FirstMouse, FirstMouse+, Support*
- ◆ Audio (Microphone and Speaker) Support
- ◆ Special Design for Easy Stacking
- ◆ Rack Mountable in 19" (1U) System Rack

- *
 1. PS/2 compatible mouse support is for three button (wheel) mice.
 2. The Logitech Mouse Ware program's *Change Device* procedure does not work on Microsoft NT systems.

HARDWARE REQUIREMENTS

CONSOLES

- A VGA, SVGA, or Multisync monitor capable of the highest resolution that you will be using on any computer in the installation.



If a monitor switches to a computer using a resolution that is higher than the resolution that the monitor can support, serious damage to the monitor may result.

- A PS/2 style mouse
- A PS/2 style keyboard
- Microphone and Speakers (Optional)

COMPUTERS

The following equipment must be installed on each computer:

- A VGA, SVGA or Multisync card.
- Either a 6-pin mini-DIN (PS/2 style), or DB-9 (standard serial), mouse port.
- Either a 6-pin mini-DIN (PS/2 style) keyboard port with +5V DC on pin 4 and Ground on pin 3, or a 5-pin DIN (AT style) keyboard port with +5V DC on pin 5 and ground on pin 4.

CABLES



Use of substandard cables may damage the connected devices or degrade overall performance. For optimum signal integrity and to simplify the layout, we strongly recommend that you use the following high quality CS Custom Cable sets:

Computer Connector Type	CS Custom Cable
AT (5 pin DIN) Keyboard and Serial Mouse Ports	2L-1701P + Keyboard & Mouse Adapters
PS/2 (6 pin mini-DIN) Keyboard and Mouse Ports	2L-1701P
Cascading to Second Stage Master View	2L-1601P

- Note:**
1. If your computer uses a standard AT style keyboard socket you will need to purchase a PS/2-to-AT keyboard adapter (Part No. 2A-106, or any standard keyboard adapter), in order to plug the cable into the computer's keyboard port.
 2. If your computer uses a standard 9 pin serial port for the mouse, you will need to purchase a PS/2-to-Serial mouse adapter (Part No. 2A-105; a standard mouse adapter will probably not work), in order to plug the cable into the computer's serial port.

INTRODUCTION

FRONT VIEW

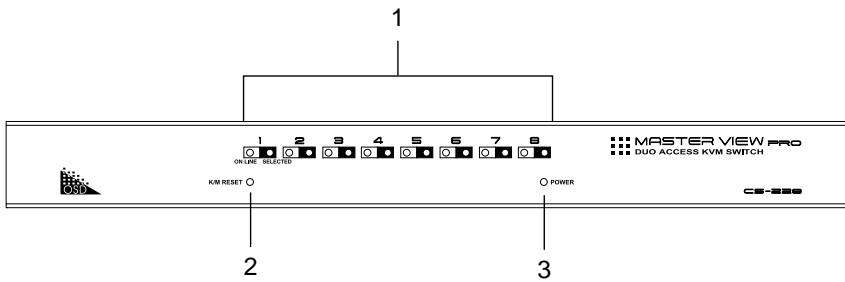

1. Port LEDs

On Line: Lights ORANGE to indicate that the computer attached to the corresponding port is up and running. If the LED is flashing, it indicates that the Port is being used for Cascading to another Master View switch.

Selected: Lights GREEN to indicate the currently selected port.

2. K/M Reset

If the keyboard and mouse get stuck and need to be reset, insert a pointed object in here and push.

3. Power LED

Lights BLUE to indicate that the CS-228 has been turned On and is receiving power.

REAR VIEW

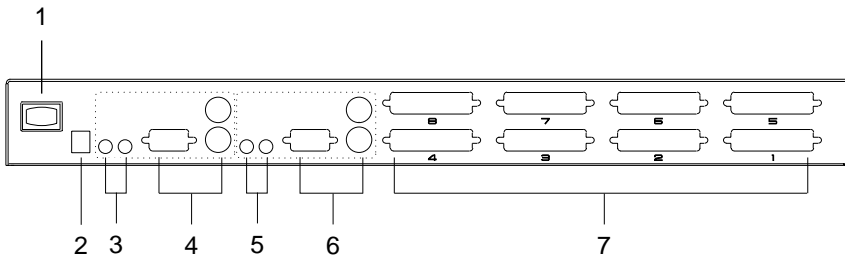

1. Power Switch

2. Power Jack

The power adapter cable plugs in here.

3. Console 2 Microphone and Speaker Jacks

The microphone and speakers belonging to Console 2 plug in here.

4. Console 2 Mouse, Keyboard, and Monitor Connectors

5. Console 1 Microphone and Speaker Jacks

The microphone and speakers belonging to Console 1 plug in here.

6. Console 1 Mouse, Keyboard, and Monitor Connectors

7. CPU Port Section

Use CS Custom Cables (as specified in the Cables section on p. 3), to connect computers, or to daisy chain second stage Master View units to any available port.

INSTALLATION AND STARTUP

BEFORE YOU BEGIN



1. Make sure that power to all the devices you will be connecting up have been turned off. You must unplug the power cords of any computers that have the *Keyboard Power On* function. Otherwise, the switch will receive power from the computer.
2. To prevent damage to your equipment due to ground potential difference, make sure that all devices on the installation are properly grounded. Consult your dealer for technical details, if necessary.

SINGLE STATION INSTALLATION

The most basic installation is a Single Stage installation, in which no additional Master Views are daisy chained down from the first unit. To set up a single stage installation do the following:

1. Plug the monitor, keyboard, and mouse cables for Consoles 1 and 2 into the port connectors located on the rear panel of the CS-228 unit. Each port is labeled with an appropriate icon to indicate itself.
2. Plug the microphone and speaker cables (if you are using them), for Consoles 1 and 2 into the port connectors located on the rear panel of the CS-228 unit. Each port is labeled with an appropriate icon to indicate itself.
3. Use 2L-1701S CS Custom Cables (as described in the Cables section on p. 3), to connect the monitor, keyboard and mouse ports of the computers to any available CS-228 CPU Port.
4. Plug the power adapter into an AC source; plug the power adapter cable into the CS-228's Power Jack.

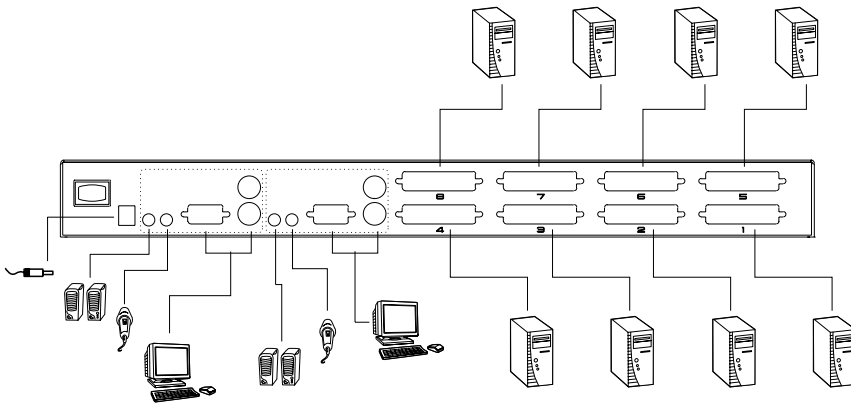

5. Turn on the power to the CS-228.

Note: When you turn the unit On, it undergoes a Power On Self Test. If there is a problem, the On Line Port LEDs flash repeatedly according to a pattern that indicates what the problem is:

Pattern	Indication
On Line LEDs 1 - 8 Flash Simultaneously	Internal RAM Memory Error
On Line LEDs 1 - 8 Flash One After the Other	External RAM Memory Error
On Line LED pairs 1+2, 3+4, 5+6, and 7+8 Flash One After the Other	ROM Test Error

If any of these problems occur, turn the Switch Off, then turn it On again.

6. Plug in the power cords and power On all the computers.

Note: You must turn on the power to the CS-228 before turning on the power to the computers.

TWO STAGE INSTALLATION

To control even more computers, up to eight additional Master View units can be cascaded from the CPU ports of the CS-228. The cascaded Master Views that connect back to the First Stage unit (the CS-228), are considered Second Stage units. As many as 64 computers can be controlled in a complete two stage installation. A table showing the relation between the number of computers and the number of Master View units needed to control them is provided in the Appendix.

Note: 1. Only Master View CS-138A, CS-9138, CS-128A, or CS-124A units can be used with the CS-228;

2. Master Views cannot be cascaded beyond the second stage.

To set up a two stage installation, do the following:

1. Make sure that power to all the devices you will be connecting up, including all preexisting devices on the installation, have been turned off (unplug the power cords of any computers that have the *Keyboard Power On* function; unplug the First Stage unit).
2. Use a 2L-1601P Custom Cable set (described in the *Cables* section, p. 3), to connect any available CPU port on the CS-228 (First Stage) unit to the Console Port connectors of the Second Stage unit.
3. Use CS Custom Cable sets (see the *Cables* section of the Second Stage unit's user manual for details), to connect any available CPU port on the Second Stage unit to the monitor, keyboard and mouse ports of the computer you are installing.
4. Repeat steps 1 - 3 for any other Second Stage units you wish to connect.
5. Plug in the power adapter cable for the First Stage Master View unit's Power Jack.
6. For each Second Stage unit, plug the power adapter into an AC source; plug the power adapter cable into the Master View's Power Jack.

7. Power on the First Stage CS-228.
8. Power on all Second Stage units
9. Plug in the power cords and power On all the computers.



You must follow the sequence in steps 4 - 8 when powering up.

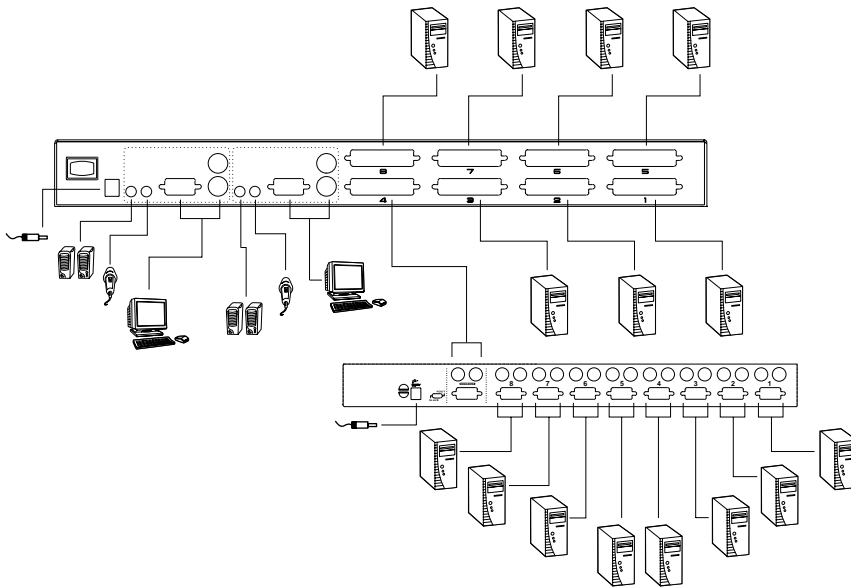

HOT PLUGGING

The Master View CS-228 supports hot plugging - components can be removed and added back into the installation by unplugging their cables from the CPU ports without the need to shut the unit down. In order for hot plugging to work properly, however, these procedures must be followed:

1. When hot plugging cables from the CPU ports the cable must be plugged back into the same port it was removed from.
2. You may unplug the mouse and plug it back in again (to reset the mouse, for example), as long as you use the *same* mouse.
If there is no response to mouse and/or keyboard after you plug the mouse back in, perform a **K/M Reset** by inserting a thin pointed object into the Reset receptacle on the unit's front panel and gently pushing.

POWERING OFF AND RESTARTING

If it becomes necessary to Power Off any of the Master View units, before starting it back up you must do the following:

1. Shut down all the computers that are attached to the unit, as well as all the stations (Second Stage Master Views) and all the computers that are daisy chained down from it (all the child stations and the computers attached to them).
Note: You must unplug the power cords of any computers that have the *Keyboard Power On* function that are connected to the shut down Master Views. Otherwise, the switches will still receive power from the computers.
2. Wait 10 seconds, then restart the CS-228.
Note: When the CS-228 comes up it issues a long beep, and the Consoles are automatically logged out. Each Console logout produces a short beep - so you will hear one long and two short beeps.
3. Restart the Second Stage Master Views.
4. After all the Master View's are up, power On the computers.

PORT SELECTION

Instant access to any computer on the installation is provided by the menu driven *On Screen Display* (OSD) function. OSD operation is discussed in the next section.

OSD OVERVIEW

On Screen Display (OSD), provides a menu driven interface to handle the computer switching procedure. All operations start from the OSD Main Menu. To activate the Main Menu, tap either Ctrl key twice.

- Note:** 1. The keys must be on the same side (both left, or both right).
2. If using the Ctrl key conflicts with applications running on the computers, you can optionally change the OSD activation key to the Scroll Lock key (see *OSD Activating Hotkey* under the **F6 Set** function on p. 16), in which case you would press [Scroll Lock] twice.

For security purposes, the OSD incorporates a two level (Administrator / User) password system. Before the OSD Main Screen comes up, a window appears that asks you to provide your password. If the password function has been set for the Console you are at, you must provide the password in order to access the OSD Main screen.

If this is the first time that the OSD is being run, or if the password function is not being used, simply press **[Enter]**. The OSD Main Screen comes up in Administrator Mode. In this mode, you have administrator privileges, with access to all User and Administrator functions, and can set up operations (including password authorization for the future), as you would like.

When you invoke the OSD, a screen similar to the one below appears:

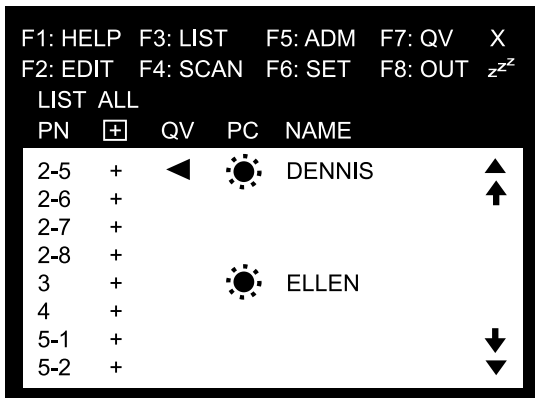

- OSD always starts in **List** view, with the highlight bar at the same position it was in the last time it was closed.
- The Port Number (PN) for each computer on the installation is shown in the left column of the list. Port numbering details are discussed in the next section.

PORT NUMBERING

The Port Number (PN) for a computer connected to the CS-228 is derived from the CPU Port (1 - 8) on the CS-228's back panel that the computer is connected to. A computer connected to CPU Port 7, for example, would have a PN of 7.

A computer connected to a daisy chained Master View has a two digit PN. The first digit represents the CPU Port of the CS-228 (the First Stage Master View) that the Second Stage Master View is chained down from; the second digit represents the CPU Port of the Second Stage Master View that the computer is connected to. A computer connected to CPU Port 3 of a Second Stage Master View that is daisy chained down from CPU Port 2 of a CS-228, for example, would have a PN of 2-3.

OSD NAVIGATION

- To dismiss the menu, and deactivate OSD, Click the **X** at the upper right corner of the OSD Window; or press **[Esc]**.
- To Logout, press **F8**, Click **F8**, or Click the **ZZ** symbol at the upper right corner of the OSD Window.
- To move up or down through the list one line at a time, Click the Up and Down Triangle symbols (**▲▼**), or use the Up and Down Arrow Keys. If there are more items than appear on the screen, the screen will scroll.
- To move up or down through the list one screen at a time, Click the Up and Down Arrow symbols (**▲▼**), or use the [Pg Up] and [Pg Dn] keys. If there are more items than appear on the screen, the screen will scroll.
- To access a port, Double Click it, or move the Highlight Bar to it then press **[Enter]**.

- Note:**
1. If you try to access a computer that has been designated as private (see *Private Mode*, p. 17), a message appears to inform you that the *Port is in Private Mode*. In this case, the screen is blank, and the port can neither be viewed, nor accessed.
 2. If you try to access a computer that is already being accessed by another Console, a message displays to inform you that the *Port is In Use*. The target computer's screen can be viewed, but you cannot give it any input until the Console that already has control stops accessing it.
 3. In a cascaded installation, if a computer attached to a Second Stage Master View is already being accessed by the other Console, that computer and all the other computers attached to the same Second Stage unit are considered to be in use. None of them can be viewed or accessed from your Console. This is so, because accessing any one computer attached to a Second Stage unit ties up the entire CS-228 Port that their Second Stage unit is cascaded down from. Only after the original Console no longer has access - either because it relinquishes access, or because the timeout delay (see *Set Logout Timeout*, p. 16), has been exceeded - can these computers be controlled from another Console.

- After executing any action, you automatically go back to the menu one level above.

OSD MAIN MENU HEADINGS

Heading	Explanation
PN	This column lists the Port Numbers for all the CPU Ports. The simplest method to access a particular computer (assuming you know which port it is attached to), is to Double Click it with the Mouse; or to use the Navigation Keys to move the Highlight Bar to it, then press [Enter] .
	Indicates ports that this Console can access. This Console cannot access ports that do not have this symbol displayed. Permission for a particular Console to be able to access a port is granted by the Administrator (see <i>Set Accessible Ports</i> , p. 15).
QV	An <i>arrowhead</i> symbol in this column indicates the Port has been selected for Quick View Scan Mode (see F7 , p. 18).
PC	A <i>sun</i> symbol in this column indicates that the computer connected to this Port is powered On, and is On Line.
NAME	If a port has been given a name (see F2 , p. 13), its name appears in this column.

OSD FUNCTIONS

OSD functions are used to configure and control the OSD. For example, you can: rapidly switch to any port; scan selected ports only; limit the list you wish to view; designate a port for Quick View scanning; create or edit a port name; or make OSD setting adjustments.

To access an OSD function:

1. Either Click a Function Key field on the screen, or press a Function Key on the keyboard.
2. In the Submenus that appear, make your choice either by Double Clicking it, or moving the Highlight Bar to it.
3. Press **[Esc]** to activate your choice and return to the previous menu level.

◆ F1 HELP:

Help provides a quick guide to OSD operation. To return to the OSD Main Menu, Click the **X** at the upper right corner of the OSD Window; or press **[Esc]**.

◆ **F2 EDIT:**

This is an Administrator function. To help remember which computer is attached to a particular port, every port can be given a name. The Edit function allows the Administrator to create, modify, or delete port names. To Edit a port name:

1. Click the port you want, or use the Navigation Keys to move the highlight bar to it.
2. Click the F2 field, or Press **[F2]**.
3. Key in the new Port Name, or modify/delete the old one.
The maximum number of characters allowed for the Port Name is 15. Legal characters include:
 - ◆ All alpha characters: a - z; A - Z
 - ◆ All numeric characters: 0 - 9
 - ◆ +, -, /, :, ., and SpaceCase does not matter; OSD displays the Port Name in all capitals no matter how they were keyed in.
4. When you have finished editing, press **[Enter]** to have the change take effect. To abort the change, press **[Esc]**.

◆ **F3 LIST:**

This function lets you broaden or narrow the scope of which ports the OSD lists. This will be different for each Console, depending on the choices made for that Console. The choices and their meanings are given in the table, below:

Choice	Meaning
ALL	Lists the Port Numbers and Names (if names have been specified - see F2), of all the ports on the installation.
QVIEW	Lists only the ports that have been selected for Quick View scanning (see F7).
POWERED ON	Lists only the ports that have their attached computers Powered On.
POWERED ON + QVIEW	Lists only the ports that have been selected for Quick View scanning (see F4), and that have their attached computers Powered On.
QVIEW + NAME	Lists only the ports that have been selected for Quick View scanning (see F7), and have been assigned names (see F2).
NAME	Lists only the ports that have been assigned names (see F2).

Double Click the choice you want, or move the Highlight Bar to it then press **[Enter]**. An icon appears before the choice to indicate that it is the currently selected one.

- Note:**
1. You can access any port on any list by Double Clicking it, or using the Navigation Keys then pressing **[Enter]**.
 2. If you select a port that does not have a computer attached to it, or if the attached computer is powered Off, the OSD will still switch to it, and will not show an error. To recover, press the OSD Activation Hotkey.

◆ **F4 SCAN:**

Clicking the F4 field, or pressing [F4] initiates *Scan Mode*, in which the OSD cycles through all the ports that have been selected for scanning with the *Scan Mode* setting (see p. 17). When you want to stop at a particular location, press the **[Spacebar]** to stop scanning.

- Note:**
1. If the scanning stops on an empty port, or one where the computer is attached but is powered Off, the monitor screen will be blank and the mouse and keyboard will have no effect. To recover, To recover, press the OSD Activation Hotkey.
 2. As the OSD cycles through the selected ports, an **[S]** appears in front of each accessed computer's Port ID display to indicate that the computer is being accessed under Quick View Scanning.
 3. If a particular port is being accessed by another Console, an **[R]** appears in front of the Port ID display to indicate that the Port is "View Only." It can be viewed, but cannot be accessed at this time.
 4. If a particular port has been designated as private (see F6, below), a **[P]** appears in front of the Port ID display to indicate that the Port is in "Private Mode." The screen is blank, and the port can neither be viewed, nor accessed.
 5. If a particular port was accessed by one of the Consoles, but is no longer being accessed, the OSD begins a Timeout countdown (see *Set Access Timeout* p. 15, and *Set Logout Timeout* p. 16, in the F5 ADM section), a **[Z]** appears in front of the Port ID display to indicate that the Port is Pending (i.e., the original Console that accessed can still reclaim it, but if it doesn't access the Port before the Timeout period ends, it is up for grabs to the first comer).

◆ **F5 ADM:**

F5 allows an Administrator to configure the OSD operation of the Console. To change a setting Double Click it; or use the Up and Down Arrow Keys to move the highlight bar to it then press **[Enter]**.

- Note:**
1. To avoid Administrator conflict, a priority system has been set up in which, by default, Console 1 has priority over anything attached to Port 1, and Console 2 has priority over anything attached to Port 2.
 2. Only one Administrator may access the F5 ADM (Administrator) function at a time. If a second Administrator attempts to access the F5 function while it is already being accessed, he is denied access, and a message appears on screen to inform him of the rejection.

After you select an item, a submenu with further choices for you to select from appears. Double Click the choice you want, or move the Highlight Bar to it, then press **[Enter]**. An icon appears before the selected choice so that you know which one it is. The settings are explained in the following table:

Setting	Function
SET PASSWORD	<p>This function is used to set passwords for the Administrator and User:</p> <ol style="list-style-type: none"> 1. One Administrator and two User passwords can be set. 2. Move the highlight bar to User or Administrator, then press [Enter]. A screen that allows you to key in the password appears. The password may be up to 8 characters long, and can consist of any combination of letters and numbers (A - Z, a - z, 0 - 9). 3. For a new password, key in the new password. To modify or delete a previous password, use the backspace key to erase individual letters or numbers, then key in the new password. 4. Press [Enter]. You are asked to key the password in again, in order to confirm that it is correct. 5. Key in the new password again, then press [Enter]. If the two entries match, the new password is accepted. If the entries do not match, you must start again from the beginning. 6. If the Administrator wants to change a User's password, he must enter his Administrator's password first.
SET ACCESSIBLE PORTS	<p>This function allows Administrators to select which Ports can be accessed from a particular Console. Move the highlight bar to the target computer, then press [Enter] or the [Spacebar] to toggle access On and Off. If access is On, a plus mark (+) appears to indicate so. If access is Off, the area is blank. Make your choice, then press [Esc] to confirm.</p>
SET MULTIUSER MODE	<p>This function determines whether or not the same ID can be used to log into the CS-228 from the second Console at the same time that it is being used at the first one.</p> <ol style="list-style-type: none"> 1. If Disabled, the same ID cannot be used; if Enabled (the default), the same ID can be used to log in from the second Console. 2. If Enabled, the F4, F6, and F7 settings set for any one Console, will be the same for all other Consoles that log in with the same ID. 3. Changes made to the F4, F6, and F7 settings by any logged in Console will automatically affect all Consoles with the same ID.
SET ACCESS TIMEOUT	<p>This function is used to set the timeout value to control the release of access rights to a computer. If the original Console doesn't access the computer before the timeout value is reached, the computer becomes available to the other Console. To set the timeout value, key in a number from 2 - 255 seconds, then press [Enter] (if the number is 0 (zero), this function is disabled. Default is 10 seconds.</p>
CLEAR THE NAME LIST	<p>This function is used to undo all Administrator changes and return the setup to the original factory default settings. Note: While this function is in progress, make sure that no other operations are performed on the other Console.</p>
RESTORE DEFAULT VALUES	<p>This function is used to undo all Administrator changes and return the setup to the original factory default settings - except for the Names that were assigned to Ports, which are saved.</p>

(F5 Settings cont.)

Setting	Function
RELEASE ALL PRIVATE	Releases all Ports that have been set to Private Mode (see <i>Private Mode</i> , p. 17), so that they become accessible to all Consoles.
SET LOGOUT TIMEOUT	If a Console that has accessed a computer isn't used for the amount of time set with this function, the Operator is automatically logged out. A login is necessary before the Console can be used again. This enables the other Console to gain access to the computers when the original Console is no longer accessing them, but the Operator has forgotten to relinquish access. To set the timeout value, key in a number from 1 - 255 minutes, then press [Enter] If the number is 0 [zero], this function is disabled.

◆ **F6 Set:**

[F6] allows you to configure the OSD settings for the Console you are working at. To change a setting:

1. Double Click it; or move the highlight bar to it, then press **[Enter]**
2. Press [Esc] to activate it.

After you select an item, a submenu with further choices appears. To make a selection, either Double Click it; or move the Highlight Bar to it, then press **[Enter]**. An icon appears before the selected choice to indicate which one it is. The settings are explained in the table below:

Setting	Function
OSD ACTIVATING HOTKEY	Selects which Hotkey activates the OSD function: [Ctrl] [Ctrl] (the default) or [Scroll Lock] [Scroll Lock] . The Scroll Lock option is provided in case the Ctrl key combination conflicts with programs running on the computers.
CHANNEL DISPLAY MODE	Selects how the Port ID is displayed: the Port Number plus the Name (PN + NAME); the Port Number alone (PN); or the Name alone (NAME).
CHANNEL DISPLAY DURATION	Determines how long a Port ID displays for after a port change has taken place. The choices are: User Defined - which lets you select the amount of time that the Port ID displays for after a port change has taken place (from 1 - 255 sec.); and Display Always On - which displays the Port ID at all times. If you select <i>User Defined</i> , key in the number of seconds, then press [Enter] . The default is 3 Seconds.

(F6 Settings cont.)

Setting	Function
CHANNEL DISPLAY POSITION	Allows you to position where the Port ID appears on the screen. Highlight this item, then press [Enter] ; use the Mouse or the Arrow Keys to position the Port ID display, then Double Click or press [Enter] to lock the position and return to the <i>Set</i> submenu.
SCAN MODE	Selects which Ports are available for scanning. There are six choices: ALL - All the Ports which have been set Accessible (F5); QVIEW - Only those Ports which have been set Accessible (F5) and have been selected for Quick View Scanning (F7); POWERED ON - Only those Ports which have been set Accessible (F5) and are Powered On; POWERED ON + QVIEW - Only those Ports which have been set Accessible (F5) and have been selected for Quick View Scanning (F7) and are Powered On; QVIEW + NAME - Only those Ports which have been set Accessible (F5) and have been selected for Quick View Scanning (F7) and have been named (F2); NAME - Only those Ports which have been set Accessible (F5) and have been named (F2).
SCAN DURATION	Determines how long the display dwells on each port when it cycles through the selected ports in <i>Quick View Scan Mode</i> . Key in a value from 1 - 255 seconds, then press [Enter] . Default is 3 seconds.
PRIVATE MODE	The [Enter] key is a toggle that Enables/Disables Private Mode for the currently selected port. When Private Mode is Enabled, the other Console cannot access the port, and its monitor shows a blank screen when it comes to it. If the other console tries to access the port, the message: Private Mode: Console x (x represents the number of the Console that has set private mode), displays on its screen. When you have finished making your selections, press [Esc] to return to the OSD Main Menu.
RESTORE DEFAULT VALUES	This function is used to undo all User changes and return the setup to the original factory default settings - except for the Names that were assigned to Ports, which are retained.
MOUSE BUTTON SETUP	This function allows you to set the mouse for right or left handed operation. Use [Enter] to toggle between the two.
SET PASSWORD	<p>This function is for Users to set their passwords:</p> <ol style="list-style-type: none">1. When you access this function, if you already have a password you must enter it in order to continue.2. A screen appears that allows you to key in your new password. The password may be up to 8 characters long, and can consist of any combination of letters and numbers (A - Z, 0 - 9).3. To modify or delete a previous password, use [Backspace] to delete the characters.4. Key in the password, then press [Enter]. You are asked to key the password in again, in order to confirm that it is correct. Key in the new password again, then press [Enter]. <p>If the two entries match, the new password is accepted. If the entries do not match, you must start again from the beginning.</p>

◆ F7 QV

You can broaden or narrow the number of ports that get automatically scanned by selecting only the ones you want with the QV (Quick View Scan) function. [F7] is a toggle that selects or deselects the currently highlighted port for the Quick View Scanning function (see F4, above). To select/deselect a port for Quick View Scanning:

1. Double Click the port you want, or use the Navigation Keys to move the highlight bar to it.
2. Press [F7].

When a port has been selected for Quick View Scanning, an arrowhead displays in the QV column to indicate so. When a port is deselected, the arrowhead disappears.

◆ F8 Out

Clicking the F8 field, or pressing [F8] logs you out of OSD control of the computers, and blanks the Console screen. This is different from simply pressing [Esc] to deactivate the OSD, since with this function you must log in all over again to regain access to the OSD.

- Note:**
1. When you reenter the OSD after logging out, the screen stays blank except for the OSD Main Menu. You must input your password before you can continue.
 2. If you reenter the OSD after logging out, and immediately use [Esc] to deactivate the OSD without having selected a port from the OSD menu, a *Null Port* message displays on the screen, and the system reverts to Logout status.

FACTORY DEFAULT SETTINGS

The factory default settings are as follows:

Setting	Default
MULTIUSER MODE	Enabled
ACCESS TIMEOUT	10 Seconds
OSD HOTKEY	[Ctrl] [Ctrl]
DISPLAY MODE	The Port Number plus the Port Name
DISPLAY DURATION	3 Seconds
SCAN DURATION	3 Seconds

APPENDIX

MASTER VIEW - COMPUTER CONNECTION TABLES

Master Views	Type	Computers
1	CS-228	1 - 8
2	CS-128A / CS-138A / CS-9138	8 - 15
3	CS-128A / CS-138A / CS-9138	15 - 22
4	CS-128A / CS-138A / CS-9138	22 - 29
5	CS-128A / CS-138A / CS-9138	29 - 36
6	CS-128A / CS-138A / CS-9138	36 - 43
7	CS-128A / CS-138A / CS-9138	43 - 50
8	CS-128A / CS-138A / CS-9138	50 - 57
9	CS-128A / CS-138A / CS-9138	57 - 64

Master Views	Type	Computers
1	CS-228	1 - 8
2	CS-124A	8 - 11
3	CS-124A	11 - 14
4	CS-124A	14 - 17
5	CS-124A	17 - 20
6	CS-124A	20 - 23
7	CS-124A	23 - 26
8	CS-124A	26 - 29
9	CS-124A	29 - 32

TROUBLESHOOTING

Symptom	Possible Cause	Action
Keyboard and/or Mouse not responding.	The connection from the selected port to the target computer has been broken, or the computer is turned OFF.	Check the Online LED for the selected port. If it is not lit: 1. Check to see that the computer is powered ON. 2. Check the cables to make sure they are all properly connected.
	Keyboard/Mouse need to be reset.	1. Unplug the keyboard and/or Mouse connector from the Console Keyboard and/or Mouse Ports, then plug it/them back in. 2. Use a thin object (such as the end of a paper clip, or a ballpoint pen), to press the K/M Reset Switch (located on the front panel), in.

SPECIFICATIONS

Function		Specification
Computer Connections	Direct	8
	Max	64 (via Daisy Chain)
Port Selection		OSD (On Screen Display)
LEDs	Power	1 (Blue)
	On Line Port	8 (Orange)
	Selected Port	8 (Green)
Console Connectors	Keyboard	2 x 6 pin mini-DIN female
	Mouse	2 x 6 pin mini-DIN female
	Video	2 x HDB-15 female
	Audio	2 x Microphone Jacks 2 x Speaker Jacks
Computer Port Connectors		8 x 25 pin D Type female
On Screen Display (OSD)		PC Names; ID Numbers; Port Status
Scan Interval (OSD Select)		User Specified: 1 - 255 secs.
Emulation	Keyboard	PS/2 and PC/AT
	Mouse	PS/2 and Serial
Video		1920 x 1440; DDC2
Power Consumption		DC 9V; 7.2W (max.)
Operating Temperature		5 - 40° C
Storage Temperature		-20 - 60° C
Humidity		0 - 80% RH
Housing		Metal
Weight		2700 g
Dimensions (L x W x H)		433.5 x 153 x 44 mm (19" 1U)

STACKING AND MOUNTING

◆ Stacking:

1. The unit comes with the stacking brackets already attached. Note that there is a top and bottom half to each bracket. The top half has a convex surface; the bottom half has a concave surface.
2. Line up the four bottom brackets of the top unit with the four top brackets of the bottom unit; then fit the top unit down onto the bottom unit.

◆ Rack Mounting

To rack mount the unit do the following:

1. First remove the stacking brackets by unscrewing them from the unit, as shown in the diagram below:

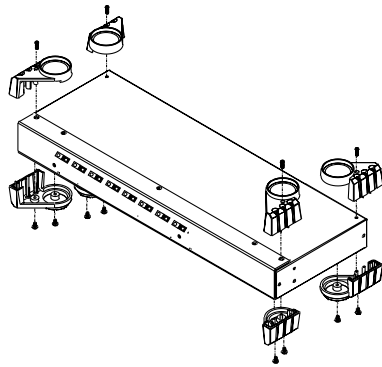

2. Screw the mounting brackets into the sides of the unit, as shown in the diagram below:

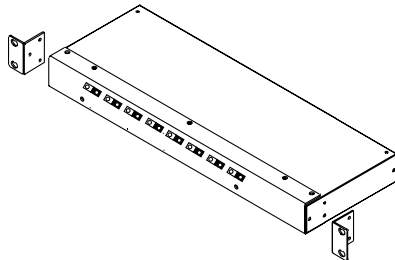

3. Slide the unit into the rack and secure it to the rack.



RADIO & TV INTERFERENCE STATEMENT

WARNING!!! This equipment generates, uses and can radiate radio frequency energy and, if not installed and used in accordance with the instruction manual, may cause interference to radio communications. This equipment has been tested and found to comply with the limits for a Class A computing device pursuant to Subpart J of Part 15 of FCC Rules, which are designed to provide reasonable protection against such interference when operated in a commercial environment. Operation of this equipment in a residential area is likely to cause interference, in which case the user at his own expense will be required to take whatever measures may be required to correct the interference.

LIMITED WARRANTY

IN NO EVENT SHALL THE DIRECT VENDOR'S LIABILITY EXCEED THE PRICE PAID FOR THE PRODUCT FROM THE DIRECT, INDIRECT, SPECIAL, INCIDENTAL OR CONSEQUENTIAL DAMAGES RESULTING FROM THE USE OF THE PRODUCT, DISK OR ITS DOCUMENTATION.

The direct vendor makes no warranty or representation, expressed, implied, or statutory with respect to the contents or use of this documentation, and specially disclaims its quality, performance, merchantability, or fitness for any particular purpose.

The direct vendor also reserves the right to revise or update the device or documentation without obligation to notify any individual or entity of such revisions, or update. For further inquires please contact your direct vendor.

2001-02-01

